

SPRAYMAXX



Read and fully understand
the instructions before operating
the Portek SprayMaxx

portek.co.uk

60 litre &
90 litre models

**ATV / UTV
Mounted Sprayer**

Operator's Handbook

Contents

CONTENTS

Before You Start	3
Safety Information	4
Introduction	5
Assembly	6
Set Up	7
Calibration	8 - 9
Filling, Mixing & Spraying	10 - 11
Cleaning, Maintenance & Storage	12 - 13
Parts Diagram & Parts List	14 - 15
Technical Data	16 - 17
Warranty	18 - 19
Declaration of Conformity	20



READ AND UNDERSTAND THIS MANUAL FULLY BEFORE OPERATING THE SPRAYMAXX



This user manual accompanies the SprayMaxx ATV/UTV Mounted Sprayer and contains important information on set up and handling. Before using the equipment, read the user manual carefully. This particularly applies to the safety notes. Failure to do so may result in personal injury or damage to the equipment. Store the user manual for further use.

This graphic accompanied by the words **WARNING** and **DANGER** highlights an act or a condition which can lead to **SERIOUS INJURY**.



ALWAYS WEAR THE CORRECT PROTECTION.

ALWAYS WEAR SAFETY CLOTHING IN CONJUNCTION WITH HAND, EYE, HEAD, HEARING AND FOOT PROTECTION TO HSE/EN SPECIFICATIONS

RESIDUAL RISKS





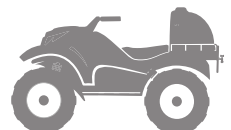

This machine is only designed for the spraying of herbicides and pesticides. Use the product only if you fully understand all the functions and can perform without restrictions, or have received appropriate instructions. Respect technical data and safety precautions. Do not use this product in any other way as stated for normal use. Not observing general regulations in force and instructions from this manual does not make the manufacturer liable for damages.

Please note that our equipment has not been designed for commercial, trade or industrial use. If the equipment is used in commercial, trade or industrial operation or for similar activities, we cannot assume any liability. Specifications, descriptions and illustrative material in this manual are as accurate as known at the time of publication, but are subject to change without notice. Illustrations may include optional equipment and accessories, and may not include all standard equipment.

Even when the device is used properly and all safety regulations are complied with, there still may be some residual risks, which cannot be prevented.



Safety Information

Symbol	Meaning	Symbol	Meaning
	Read instruction manual before use.		Denotes risk of personal injury or damage to the tool.
	Wear eye protection.		Do not burn.
	Wear face protection.		Children shall not play with the appliance.
			Information of the acoustic power level.



READ ALL SAFETY WARNINGS. FAILURE TO FOLLOW THE WARNINGS MAY RESULT IN SERIOUS INJURY OR EVEN DEATH.

1. Keep children and bystanders away during operation. Distractions can cause you to lose control and increase risk of injury.
2. Check for signs of wear or damage, before using the SprayMaxx and after any impact, and repair as necessary.
3. The SprayMaxx is designed for use by adults. Young people over 16 years may use the tool under supervision only.
4. The manufacturer is not liable for damage which is caused through inappropriate use or incorrect operation.



WARNING! Use Personal Protective Equipment (PPE). Always wear face protection when working with the machine. Wear protective clothing, leg protection, safety gloves and non-slip safety shoes used for appropriate conditions will reduce personal injuries. Wear ear protectors, as exposure to noise can cause hearing loss.

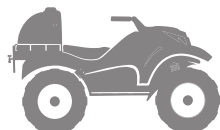



INTRODUCTION

Congratulations on the purchase of your SprayMaxx ATV/UTV Sprayer, which has been designed for the spraying of herbicides and pesticides. The design of the tank enables the unit to be mounted on to the cargo rack of an ATV, UTV, pick up or trailer.



WARNINGS:

- When mounting to any vehicle ensure that you have read the vehicle Owner's Manual and make sure you comply with all the weight restrictions as specified by the vehicle manufacturer, as overloading can cause injury or death.
- To ensure your own safety and that of your employees, if applicable, you must comply with all relevant environmental, work place health and safety legislation and codes of practice.
- Select and wear appropriate PPE in accordance with the label of the product you intend using and your own safe work practices. PPE must still be worn while cleaning/decontaminating the SprayMaxx.
- Care should be taken when spraying in windy conditions as spray drift may contaminate the air and may effect the operator or damage adjacent non-target vegetation.
- Once the spraying operation has been completed, decontaminate the spray tank and spray accessories. Dispose of tank risings in compliance with current environmental, work place health and safety requirements.

ALWAYS WEAR SAFETY CLOTHING IN CONJUNCTION WITH HAND, EYE, HEAD, HEARING AND FOOT PROTECTION TO HSE/EN SPECIFICATIONS

WORK SAFELY



Do not drive across slopes

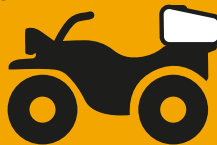

Do not exceed manufacturers' loading specifications

Ensure that all manufacturers' instructions are followed regarding the loading capacity of the ATV.

The correct use of chemicals **MUST** be followed at all times - refer to official documentation.

Got a technical question? Email us at design@portek.co.uk

Assembly & Operation

ASSEMBLY

The following steps are given as a guide to assemble your SprayMaxx sprayer:

1. Check inside the tank for any foreign objects.
2. Remove the pressure gauge from parts bag and fit onto sprayer.
3. Fit lid on top of the tank.

OPERATION

The following steps are given as a guide to operate your SprayMaxx sprayer:

- When mounting the sprayer to a vehicle using the ratchet tie-down straps, check that the spray tank is still secure after the first 15 minutes of operation and re-tighten as necessary.
- Partially fill the tank with clean water.
- Connect the battery clips to a 12V DC power supply (red to the positive terminal, black to the negative terminal) ensuring sufficient current capability (amps) to suit the pump. The pump's maximum amperage requirement can be found on its name plate.
- In order to prime the system and enable the pump to reach full pressure, depress the hand lance trigger to release any trapped air. The pump may automatically switch off when the hand lance trigger is released.
- Pump cycling may occur with insufficient nozzle delivery. This continual switching on and off will reduce the battery and motor life. Should this occur, adjust the setting of the nozzle tip or the regulator until the cycling stops.

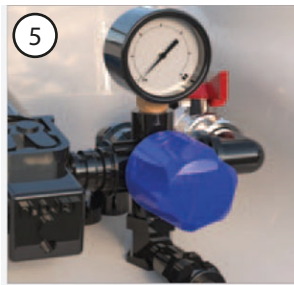
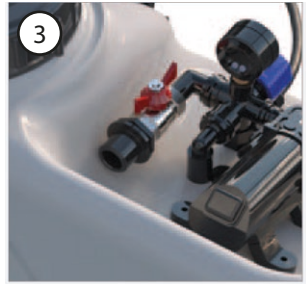
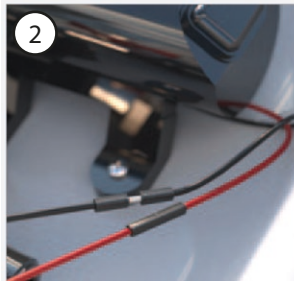
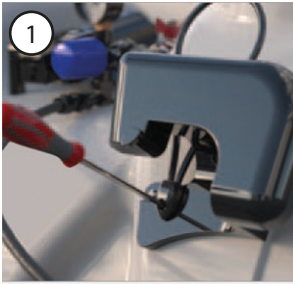

1. Securely fix the two hose wrap brackets to the SprayMaxx tank with the fittings provided.
2. Connect the SprayMaxx wire harness using the bullet connectors at the pump and then connect to your 12 volt power source/battery.
3. If you would like to mount an optional boom, you can connect it by the 'boom port' on the side of the pump.
4. Fill the SprayMaxx tank with water.
5. Before running the pump make sure the regulator is fully open to avoid premature wear or damage to the pump. Squeeze the hand gun trigger to start discharge and then adjust the pressure to your desired setting while keeping the gun trigger engaged.

NOTE: To maximize the pump's life, maintain pressure settings that do not cause the pump to pulsate whenever possible.

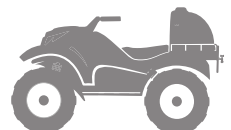

Calibration

1. Measure Nozzle Spacing: Measure the distance between each nozzle to determine the length of your travel distance.

Nozzle Spacing	=	Distance to Travel
40cm (16")	=	78m (255')
45cm (18")	=	70m (227')
50cm (20")	=	62m (204')
55cm (22")	=	56m (185')
60cm (24")	=	52m (170')

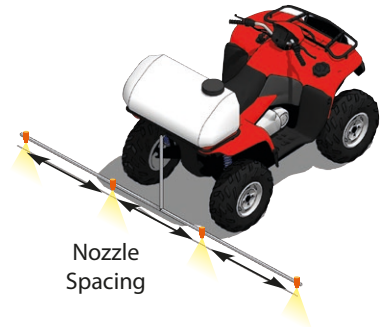

2. Measure Distance to Travel: Mark the distance with two flags or between fence posts. A tape measure capable of measuring further than 60m (200 ft), will make this easier.
3. Drive Measured Distance: Driving the sprayer at the intended spraying speed, time how long it takes to travel between the marked distance. Repeat this procedure a number of times and average the measurements. ie average time across the number of runs.

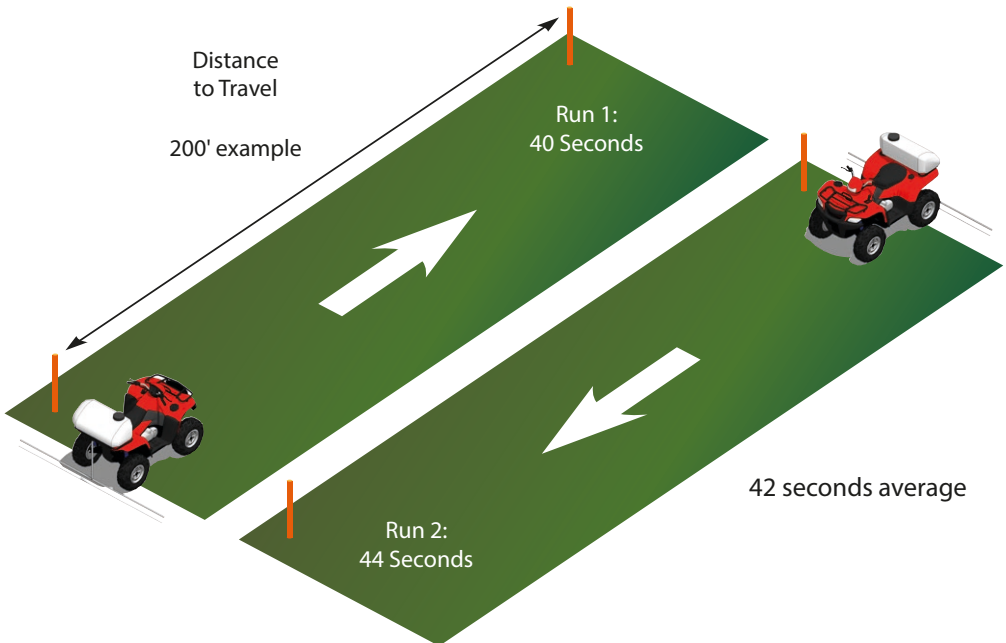

4. Set Correct Spraying Pressure: With the sprayer parked and the pump running, set the ideal or intended pressure. REFER TO CHEMICAL SUPPLIER

5. Catch Output From Each Nozzle: Catch the fluid output in a container (marked in oz) for the same number of seconds it took to drive the measured distance in step 3 (42 seconds). Calculate the 'average nozzle output' by adding the individual outputs and then dividing by the number of nozzles tested.

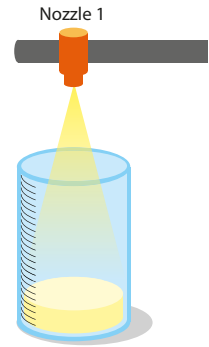

Nozzle 1	16.5 oz
Nozzle 2	16.3 oz
Nozzle 3	15.9 oz
Nozzle 4	15.3 oz
Total =	64.0 oz



64 ounces divided by 4 nozzles = 16 gallons per acre.

At this point **only** can the figure be converted to metric equivalent eg. 72.3 litres

- 6. Analyse Results: The amount of liquid captured per nozzle equals the gallons per acre application rate. (example: 16 gallons per acre).
- 7. Clean Nozzles: If the output of any nozzle deviates from the manufacturers' guidelines by more than 10%, the nozzle should be replaced or cleaned. A toothbrush works perfectly for this task.
- 8. Compare Recommended Rate: If the 1 gallon per acre rate is not within 5% of the intended rate, you will have to adjust the pressure you spray at or the speed you travel. You will have to repeat steps 3 - 7.

NOTE: This is only a basic guide on how to set up the calibration for your sprayer, there are many factors to consider when doing this process, we recommend you research the best calibration for the sprayer, the application and **choice of chemical** to be used before each use.



ALWAYS REFER TO THE CHEMICAL MANUFACTURERS' TECHNICAL INFORMATION

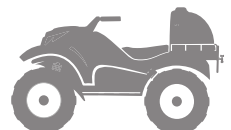

Mixing & Filling

- Read the product label and follow the instructions carefully, taking special note with regard to the order in which the products are added to the tank.
- Calibrate your sprayer according to the calibration method on page 9 using water only. Calibration must be done with the nozzle tip that has been selected for the spraying task.
- Measure out the correct quantity of pesticides using clean measuring jugs used only for this purpose.
- Half fill the SprayMaxx with clean water, then add the measured pesticide/chemical.
- Rinse out the measuring jug and empty the container. Pour all rinsings into the spray tank. Agitate by stirring with a suitable round edged paddle.
- Top up the tank with water to the required level, ensure that the tank is not over-filled and the outside is clean and dry before handling.
- Safely dispose of empty containers in compliance with current regulations.
- Mixing sites must be well away from watercourses and other environmentally sensitive areas. Children and animals must be kept away.

Planning to Spray Safely

- Before commencing spraying, plan the work effectively to reduce potential contamination.
- Wind direction and speed must be taken into account. Avoid spraying on still, hot and sunny days or when wind speed exceeds 6.5km/h.
- Do not spray if the operator, bystanders, watercourses or any non-target vegetation appears to be in danger from spray drift contamination.
- Drift can be reduced by lower nozzle height, lower pressures or by fitting larger nozzles.

Setting Up Your Spray & Adjusting the Regulator

- Prior to commencing spraying, you will need to adjust the regulator knob (blue) to suit the desired pressure and spraying style.
- Winding the regulator clockwise will increase spraying pressure. Winding it anti-clockwise will return liquid to the tank, increasing mixing and reducing spraying pressure.
- To begin, turn on the pump and activate the trigger or boom valve. Adjust the regulator to achieve the desired pressure on the gauge. Turn off the hand lance/boom valve and check to ensure the pump is not turning rapidly on and off or cycling. If the pump is cycling, you will need to reduce the spraying pressure slightly until this stops.

NOTE: To operate the hand spray lance on-demand (where the pump activates only when the trigger is pulled), wind the regulator clockwise completely until it stops. No water can return to the tank and the pump pressure switch will control the pump operation.

When Spraying

- Spray at a constant speed (as used during calibration) and shut off the hand lance trigger at the end of each swath or before changing direction.
- Work in parallel lines at the correct spacing when spraying a large area – this is better than moving the hand lance from side to side in a swinging movement which causes damage by overdosing.

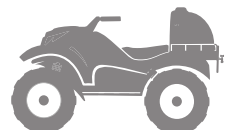

Cleaning

- **Drain Tank and Rinse:** Rinse all liquid out of the tank. When flushing the sprayer, pay attention to where the chemical will run. Always clean in an area that will not contaminate water supplies, streams or crops.
- **Pressure Wash Inside Tank:** After draining the tank, rinse the inside by spraying clean water with a pressure washer.
- **Add Clean Water:** It's now time to shut the pump off and fill the tank with clean water.
- **Flush Clean Water Through System:** Turn the pump on and spray the clean water through the boom and hand lance.
- **Add Cleaning Solution and Water:** Add the recommended cleaning solution to the tank of water. To mix, run the agitator inside the sprayer. Operate for 5-10 minutes to mix the cleaning solution with the water.
- **Let Sprayer Sit For 8 Hours:** With the water and cleaning solution left in the sprayer tank, let it sit for about eight hours. This will allow the solution to remove any herbicide from the residues inside the tank.
- **Clean Nozzles, Screens, and Filters:** It's now time to rinse all nozzles, screens and filters. To clean thoroughly, put them in a bucket of cleaning agent and water.
- **Rinse Entire System with Water:** When all nozzles, etc. are back in place, give the entire system a complete rinse to ensure all cleaning solution is flushed through the unit.

MAINTENANCE

- After use, the SprayMaxx must be thoroughly decontaminated including the tank, pump, hoses and the hand lance to avoid damage to crops from harmful spray residue and to the sprayer from corrosion or blockage.
- After spraying, flush the tank, hose and the hand lance by running it with clean water plus a recommended cleaning fluid. It is best to clean sprayers in the field or area just treated.
- The suction strainer attached to the pump suction line should be cleaned periodically. Unscrew lid, remove filter and flush with clean running water.
- Nozzle filters (if fitted), nozzle tips, nozzle caps and gaskets should be cleaned by soaking in water, brushing with a nozzle brush and allowed to dry. Never blow through the nozzles with your mouth, nor use wire or pins to clear any blockages.
- When storing your spot sprayer ensure that it is clean and dry and kept in a well ventilated place.

STORAGE

- Drain Tank: Fill the tank with clean water, start the pump and open all spray ends. If you have a spray gun or boom, make sure you spray until clean water is coming through.
- Blow out Plumbing Lines: Using compressed air, blow out the hose lines to remove all water from the system.
- Flush with Anti-freeze: Pour a small amount of anti-freeze into the tank and run the pump until there is no more coloured liquid coming through the spray ends.
- Store Sprayer Inside: Turn off the sprayer ends so the remaining anti-freeze does not leak out. If you have a boom attachment that hangs lower than the sprayer, we suggest you set the sprayer on a few pallets.

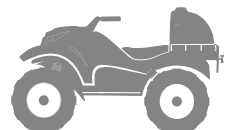

Parts List

EXPLODED DIAGRAM

For both 60 & 90 litre capacity
SprayMaxx with a 12 volt pump.

NOTE: Tank pictured is not indicative of every
model but basic equipment is the same.

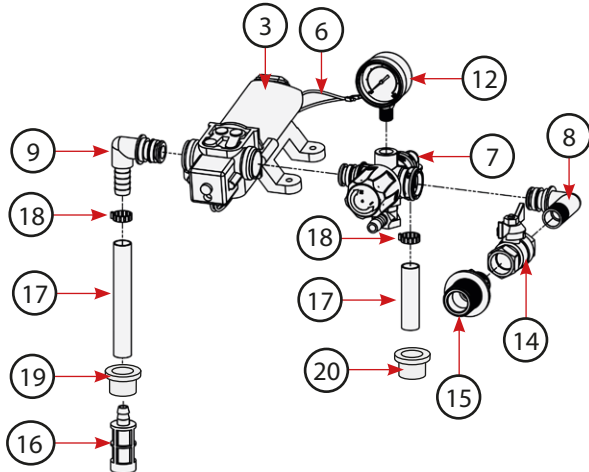
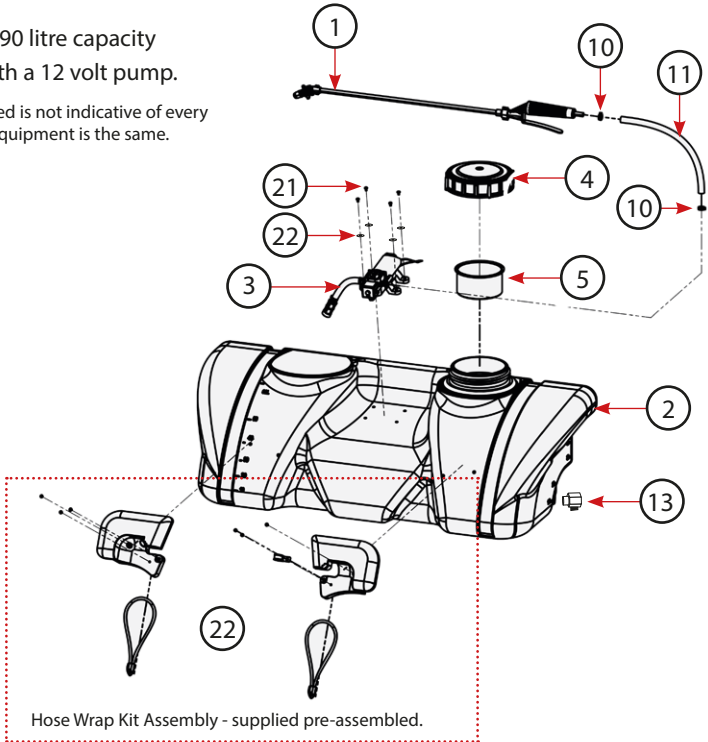

No.	Part No.	Description	No.	Part No.	Description
1	088/007	Powerjet Spray Lance	13	088/042	3/4" Ball Drain Valve
1	088/008	Economy Spray Lance	14	088/022	1/2" Mini Ball Valve F/F
2	088/136	60L Sprayer Tank	15	088/023	Reducer 1/2"m x 3/4"m
2	088/137	90L Sprayer Tank	16	088/014	Suction Filter (10mm)
3	088/003	3.8L/min Pump	16	088/011	Suction Filter (13mm)
3	088/004	8.3L/min Pump	17	088/070	1m Spray Hose (10mm)
3	088/005	15.0L/min Pump	17	088/097	1m Spray Hose (13mm)
4	088/006	150mm Screw Lid	18	088/068	3/8" Hose Clamp
5	088/045	Basket Filter	19	088/016	3/8" Top Hat Grommet (Suction)
6	088/017	2.4m 12v Electrical Leads	19	088/015	1/2" Top Hat Grommet (Suction)
7	088/019	Pressure Regulator	20	088/015	1/2" Top Hat Grommet (Return)
8	088/021	12mm Threaded Elbow	21	088/025	M5 x 25 Screws BZP
9	088/020	19mm Elbow x13mm HB	22	088/024	M5 Washer
10	088/068	3/8" Hose Clamp	23	088/146	Hose Wrap Kit includes: wrap brackets, fixings, bungee loop and hose clip (must be positioned where shown)
11	088/070A	6m Spray Hose (10mm)			
12	088/018	Gauge 0-100 Psi			

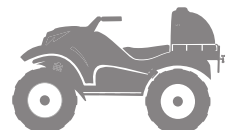

Technical Data



60 Litre Range

Easily mounted on the back on an ATV (such as a quad bike), these sprayers are fitted with a hand lance that provides thorough and adjustable spray coverage. Spray booms and boomless sprayers are available.

60 Litre **3.8**

3.8L/min Pump

- 40PSI 12 Volt Pump
- 6m Hose and Hand Lance
- 2.4m Power Wiring c/w Battery Clips
- 2x Ratchet Straps

Order No.	081-601
Capacity	3.8L/min
Dimensions (W x L x H mm)	1000 x 370 x 400
Weight (full)	72 kg

60 Litre **8.3**

8.3L/min Pump

- 60PSI 12 Volt Pump
- Pressure Regulator & Gauge
- 6m Hose and Hand Lance
- 2.4m Power Wiring c/w Battery Clips
- 2x Ratchet Straps

Order No.	081-602
Capacity	8.3L/min
Dimensions (W x L x H mm)	1000 x 370 x 400
Weight (full)	75 kg

60 Litre **15**

15L/min Pump

- 60PSI 12 Volt Pump
- Pressure Regulator & Gauge
- 6m Hose & Hand Lance
- 2.4m Power Wiring c/w Battery Clips
- 2x Ratchet Straps

Order No.	081-603
Capacity	15.0L/min
Dimensions (W x L x H mm)	1000 x 370 x 400
Weight (full)	75 kg



90 Litre Range

Easily mounted on the back on an ATV (such as a quad bike), these sprayers are fitted with a hand lance that provides thorough and adjustable spray coverage. Spray booms and boomless sprayers are available.

90 Litre **8.3**

8.3L/min Pump

- 60PSI 12 Volt Pump
- Pressure Regulator & Gauge
- 6m Hose and Hand Lance
- 2.4m Power Wiring c/w Battery Clips
- 2x Ratchet Straps

Order No. 081-902

Capacity 8.3L/min

Dimensions 1000 x 370 x 500
(W x L x H mm)

Weight (full) 107 kg

90 Litre **15**

15L/min Pump

- 60PSI 12 Volt Pump
- Pressure Regulator & Gauge
- 6m Hose & Hand Lance
- 2.4m Power Wiring c/w Battery Clips
- 2x Ratchet Straps

Order No. 081-903

Capacity 15.0L/min

Dimensions 1000 x 370 x 500
(W x L x H mm)

Weight (full) 107 kg

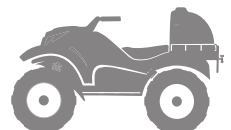

Warranty & Procedures

The following warranty is the only warranty applicable to SprayMaxx products, and to the maximum extent permitted by law, overrides any other conditions or warranties expressed or implied on SprayMaxx products. Other than legislative obligations to the contrary, Portek will not be liable for incidental or consequential damages arising from the ownership or use of a product.

No person, including any dealer or representative of Portek, is authorized to make any representation or warranty on behalf of Portek in addition or inconsistent with these provisions. Purchasers to whom these provisions apply agree to hold Portek not liable for claims by their customers in excess of the obligations of Portek expressly set forth herein.

All products sold by Portek Limited are guaranteed to be free from defect in materials workmanship or manufacture for a period of 12 months from the initial date of purchase, excepting the following exclusions:

- Any parts/products found by Portek to be defective, either in material or workmanship will be replaced or repaired within this period, at no cost to the initial purchaser if following conditions are met:
 - The item has been operated in accordance with all instructions and warnings provided.
 - Item is still owned and operated by original purchaser – proof of purchase is required to obtain warranty.

If you have any questions regarding the operation or warranty of this product, please contact us directly.

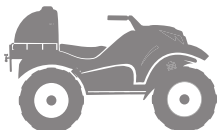

Commercial Use	All SprayMaxx machines are covered for a period of 1 year (unless stated otherwise) from the date of purchase by the Owner, when used for the designed purpose of that product by Domestic Users or if stated otherwise. When used for commercial or hire purposes the warranty is only valid for 3 months from date of purchase. Claims under warranty will be accepted up to 15 months from date of invoice to the distributor, after which proof of date of purchase is required. Charges for dealer repairs to SprayMaxx products under warranty, will only be accepted if agreed in advance.
Abuse	Failure as a result of neglect, such as improper operation. Lack of service/maintenance or continued operation after discovery of a defect that leads to further damage.
Alterations	Any unauthorised alteration, modification, attachments or unauthorised repair to equipment.
Clean-Up Time	Portek does not pay for cleaning of products, parts or accessories or work area before or after the warranty repair.
Damage	Damages or machine/component failure caused by carelessness/recklessness or accidental damage, improper operation, excessive speed, inappropriate storage or transportation.
Environmental Conditions and Application	Deteriorated or failed components such as o-rings, diaphragms, hoses, seals and connections damaged by corrosive chemicals, dirt and sand, excessive heat, moisture or other environmental impacts. Warranty determination on these type of failures will be made by Portek, only after inspection of the failed component.
Inability/ Unsuitability	In no event shall Portek be liable to any person for indirect or consequential damages or for injury or commercial loss resulting from any use or inability to use any SprayMaxx product.
Incorrect Maintenance	Component failure due to failure to perform maintenance services such as, oil and grease changes/top-ups, failure to clean tanks, pumps filters, nozzles and spray lines. Failure to tighten or replace loose or missing bolts, nuts, fittings, shields and covers.
Use of Non-Genuine Parts	Use of parts other than Portek parts for repair of warranted items will automatically negate any warranty. Warranted components must be replaced with genuine parts.

Declaration of Conformity

Declaration of Conformity

Portek Ltd, Bryn Hall, Knolton Bryn, Overton on Dee, Wrexham, LL13 0LF declare that the machinery named below conforms to the requirements of EC Council Machinery Directive Annex II.

Designation of Machinery: Portek SprayMaxx ATV Mounted Sprayer.

Relevant EC Council Directives:

2014/30/EU

2006/42/EC

2011/65/EU

The unit complies with all applicable Essential Requirements of the Directives.

Signature of Manufacturer's Representative:



Declaration made by Hugh David
Managing Director on 06/12/2021



Portek Ltd.
Bryn Hall, Knolton Bryn
Overton-on-Dee
Wrexham, LL13 0LF
Tel: 01234 889 454
Fax: 01234 889 464

General enquiries
Email: info@portek.co.uk